

# Ultra High Density Perpendicular Magnetic Recording Technologies

● Isatake Kaitsu ● Ryosaku Inamura ● Junzo Toda  
● Toshihiko Morita

*(Manuscript received July 15, 2005)*

Perpendicular magnetic recording (PMR) has been investigated for ultra high density magnetic recording since 1977. The main problems affecting PMR are wide area data erasure, deterioration of the bit error rate (BER) due to noise from the soft magnetic underlayer (SUL), and the high media production cost of a thick SUL to secure an adequate BER at high recording densities. To overcome these problems, we have developed a media and head that use new technologies. These technologies are a double recording layer with a granular recording layer, an anti-parallel structure (APS)-SUL, and a trailing shielded head. These technologies improve the performance of PMR to over 200 Gbit/in<sup>2</sup>, which is sufficient for practical use. This paper describes these media and head technologies and an investigation of signal processing for PMR channels that compares partial response (PR) targets containing a DC response.

## 1. Introduction

The consumer demand for hard disk drives (HDDs), which have mainly been used as secondary memories for computers, is rapidly growing because of the recent, strong growth of the information society. Demands for applications in other devices such as video camera recorders, car navigation systems, portable music players, and cellular phones are also emerging. At the same time, the remarkable increases in HDD recording density that are being achieved are enabling higher recording capacities and HDD downsizing. As shown in **Figure 1**, the pace of development is exceeding Moore's Law, which predicts a doubling of semiconductor integration every 18 months (which amounts to a more than 100-fold increase every 10 years). Because of this downsizing, manufactures are now producing HDDs with disks that are just 0.85 inches in diameter.

Although the steady increase in HDD recording density has been remarkable, further improvement using longitudinal magnetic record-

ing (LMR) is becoming difficult due to issues regarding the thermal stability and recording field strength. Because of these issues, perpendicular magnetic recording (PMR),<sup>1)</sup> which is a powerful recording method, has become indispensable for further improvements in magnetic recording.

There are four main problems that must be overcome before PMR can be put to practical use. The first problem is the deterioration of the bit error rate (BER) due to the noise, generally called the spike noise, from the soft magnetic underlayer (SUL). The other three problems are the wide area data erase phenomena, the high media production cost of thick SULs, and how to obtain a low BER at a high recording density.

For the first and second problems, we developed the anti parallel structure-SUL (APS-SUL) and anti ferro magnetism-SUL (AFM-SUL) technologies to control the SUL's magnetic domains. For the third problem, we developed a trailing shielded head that can generate strong effective writing fields even with thinner SULs. For the

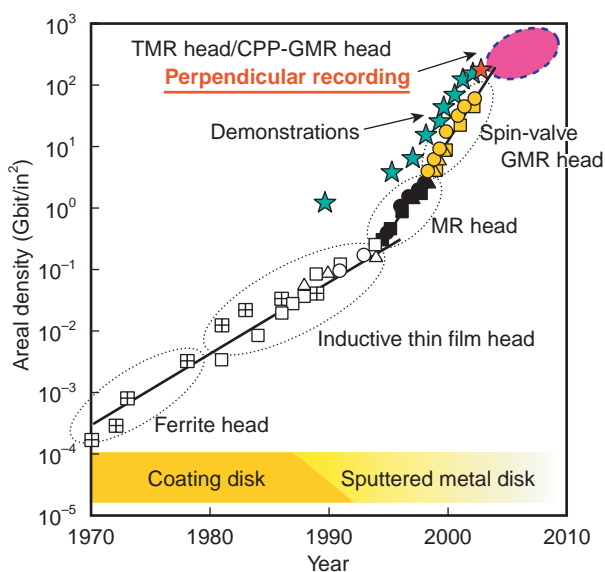

Figure 1  
Areal density trends in HDD magnetic recording.

forth problem, we developed a granular recording film and a double recording film to improve the BER and writing performance. We also examined the partial response (PR) targets for PMR from a signal processing perspective. In this paper, we describe these media and head technologies and an investigation of signal processing for PMR channels that compares PR targets containing a DC response.

## 2. Media

### 2.1 Structure of PMR media

**Figure 2** shows the structure of PMR media. They consist of a SUL, interlayer, recording layer, and carbon protective layer. In the following sections, we describe the properties of the SUL and recording layer.

### 2.2 Soft magnetic underlayer

To improve the byte error rate of PMR media, it is necessary to control the spike noise generated from the SUL. The SUL works partially to assist the write head. In the SUL, magnetization is in the plane of the film and the SUL has a magnetic domain structure. The read head detects the magnetic flux that leaks from

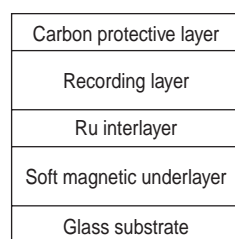

Figure 2  
Structure of over-200 Gbit/in<sup>2</sup> PMR medium.

the magnetic domain wall in the perpendicular direction. The noise detected by the read head from the SUL is known as the spike noise,<sup>2)</sup> and to control the spike noise, it is necessary to control the magnetic domain of the SUL.

We have developed two structures for reducing the spike noise: the APS-SUL and the AFM-SUL. The APS-SUL divides the SUL into several parts with very thin non-magnetic layers.<sup>3)</sup> In this structure, magnetic flux from the domain wall does not leak outside the APS-SUL but circulates into the adjacent soft magnetic layer through an anti-parallel magnetic configuration. The AFM-SUL consists of a soft magnetic layer adjacent to an anti-ferromagnetic material layer.<sup>4)</sup> The magnetization of the SUL is oriented in one direction (usually the radial direction of the recording disk) by a bias magnetic field in the anti-ferromagnetic layer. Therefore, there is no magnetic domain wall in the AFM-SUL and magnetic flux leakage from the magnetic domain wall is controlled. **Figure 3** shows the output noise from PMR media with APS, AFM, and conventional SULs. As can be seen, the APS-SUL and AFM-SUL media control the spike noise. The strong spike noise from the conventional SUL media occurs because the conventional SUL does not control the magnetic domain.

The Wide Area Track ERasure (WATER) phenomenon occurs when the bits in a recording track are repeatedly recorded and erased. It increases the BER over an area that is much wider than the track pitch.<sup>5),6)</sup> It is thought that WATER is caused by magnetic flux leakage from

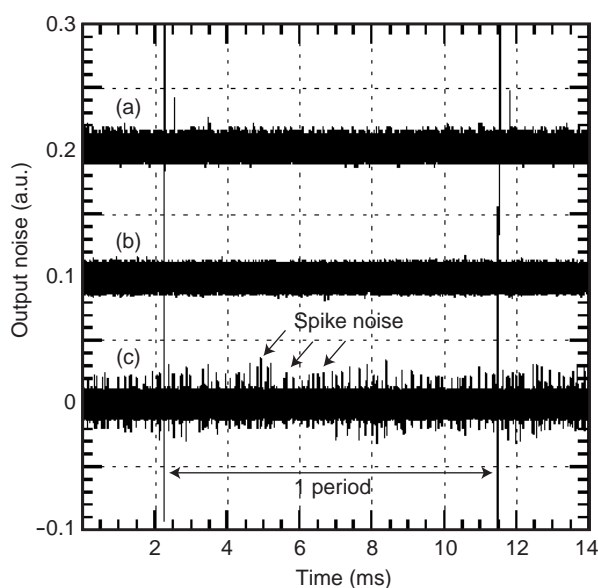

Figure 3 Output noise of PMR media with (a) APS-SUL, (b) AFM-SUL, and (c) conventional SUL after DC erasure.

the magnetic write head outside the record track when bits are recorded and erased. One of the methods for controlling WATER is to control the magnetic domain of the SUL, for example, by using an APS-SUL or AFM-SUL. **Figure 4** shows the WATER characteristics of PMR media with and without magnetic domain control in the SUL. The figure shows that even if record-erase is repeated  $10^4$  times, no deterioration of the byte error rate is seen in a PMR medium with a magnetic domain controlled SUL.

Previously, to obtain sufficient writing performance from a PMR medium, the SUL needed a soft magnetic layer that was several hundreds of nanometers thick. The thickness of the SUL film must be reduced because a thicker SUL increases the medium cost and the manufacturing capital investment needed for mass-production. On the other hand, reducing the SUL thickness reduces the writing performance and the signal-to-noise ratio (SNR).

It has recently become possible to reduce the SUL thickness while using a trailing shielded head. B. R. Acharya et al. have reported that when

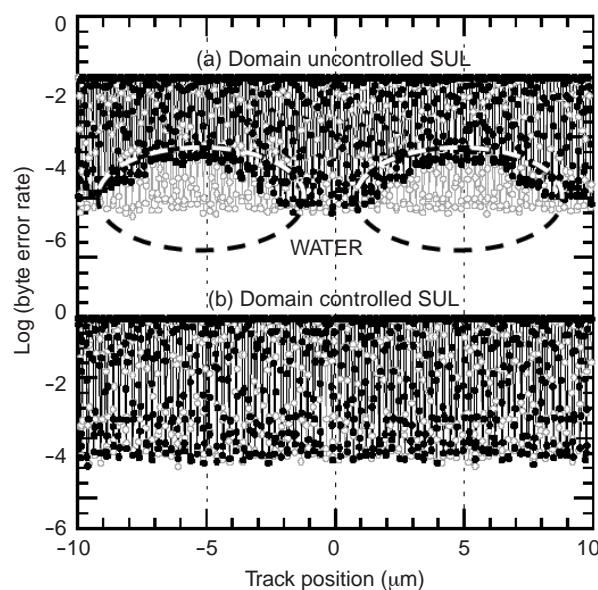

Figure 4 Initial (gray circles) and post erasure (black circles) WATER characteristic of PMR media with (a) domain uncontrolled and (b) controlled SUL.

a trailing shielded head is used with PMR media having a conventional SUL or APS-SUL, the SUL thickness can be reduced without deteriorating the SNR.<sup>3)</sup> They have also reported that a higher SNR can be obtained from a trailing shielded head/APS-SUL combination than a trailing shielded head/conventional SUL combination. **Figure 5** shows the SNR of PMR media with an APS-SUL and AFM-SUL as measured using a trailing shielded head. The SNR of the APS-SUL medium is higher than that of the AFM-SUL medium, and an improvement in SNR is obtained only with the APS-SUL medium.

### 2.3 PMR layer

To achieve higher recording densities, the recording media noise must be reduced. In the magnetic recording layer, the use of segregated, uniform grains and the improvement of crystal distribution are effective for reducing the recording media noise. When the conventional CoCrPt-alloy used by LMR media is used for the PMR layer, media noise cannot be reduced because the segregation of Cr by current heating is

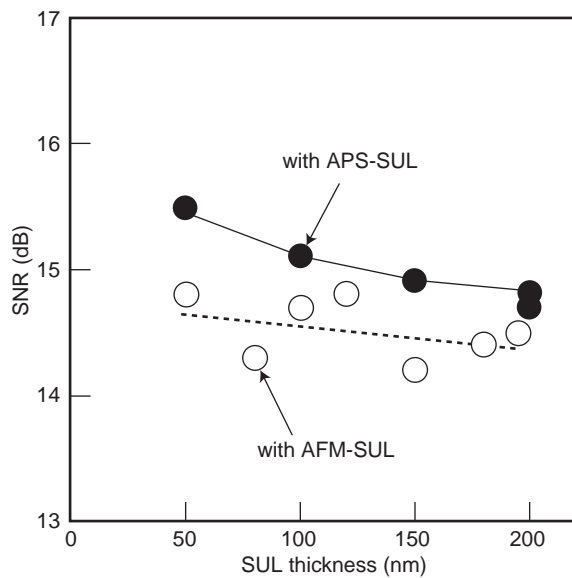

Figure 5  
Dependence of SNR of PMR media with APS-SUL (black circles) and AFM-SUL (white circles) on SUL thickness.

inadequate. In a granular material, for example, CoCrPt-O<sup>7)</sup> and CoCrPt-SiO<sub>2</sub><sup>8)</sup> systems, low noise has been achieved by reducing the magnetic interaction between magnetic grains using CoPt grain segregation with O or SiO<sub>2</sub>. This segregation can be achieved during room temperature deposition. **Figure 6** shows an in-plane transmission electron microscopy (TEM) image of a CoCrPt-SiO<sub>2</sub> granular recording layer. As can be seen, the magnetic grains are well segregated by the SiO<sub>2</sub> grain boundary.

Although it is important that the *c*-axis of the Co alloy magnetic grains grows epitaxially along the perpendicular direction of the film, it has been difficult to control the epitaxial growth of the granular material used for low-noise LMR media. However, when Ru(0002) is used as the interlayer of the PMR media, excellent growth of a *c*-axis recording layer normal to the plane of the film is achieved because of the good epitaxial growth of Co(0002) on Ru(0002). **Figure 7** shows the magnetization curve of a CoCrPt-SiO<sub>2</sub> PMR medium with a Ru interlayer. Moreover, it has been confirmed that the distribution of the *c*-axis in the perpendicular direction  $\Delta\theta_{50}$  (i.e., the full

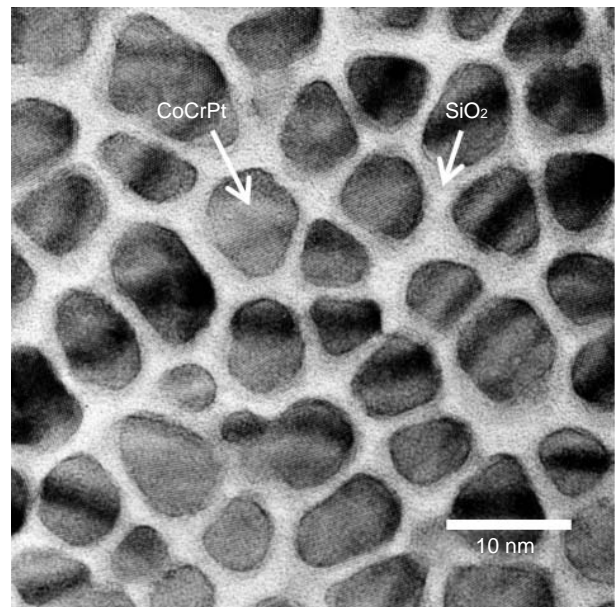

Figure 6  
In-plane TEM image of CoCrPt-SiO<sub>2</sub> layer.

width at half maximum of the rocking curve) in this CoCrPt-SiO<sub>2</sub> medium is 4 degrees or less. In addition, to further reduce the noise, the magnetic grain isolation of the CoCrPt-SiO<sub>2</sub> recording layer can be promoted by high gas pressure deposition of a Ru interlayer.

**Figure 8** shows the dependence of SNR and normalized noise on the linear recording density of CoCrPt-SiO<sub>2</sub> PMR media and conventional CoCr-alloy PMR media. By combining a CoCrPt-SiO<sub>2</sub> granular recording layer and Ru interlayer formed by high gas pressure deposition, we can obtain a lower noise and higher SNR than that of conventional CoCr-alloy PMR media.

#### 2.4 Double recording layer medium

In PMR media, when the magnetic interaction between magnetic grains in the recording layer is reduced in order to reduce the noise, the tilt of the hysteresis loop becomes small and its width is increased.<sup>9),10)</sup> Consequently, the strength of the writing magnetic field must be increased to obtain sufficient writing performance. On the other hand, when the width of the hysteresis loop is reduced to enable the use of a weaker writing

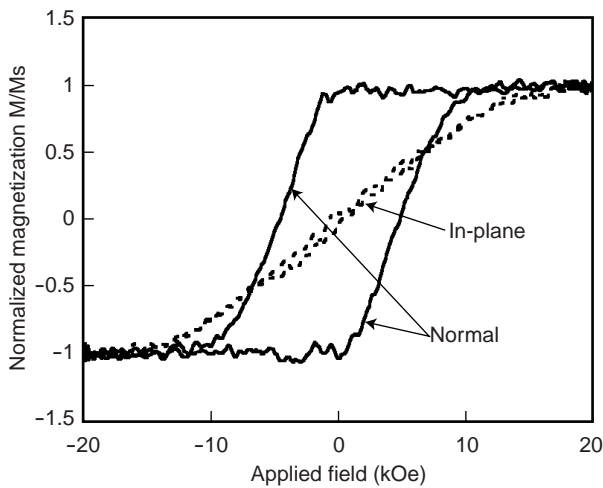

Figure 7  
Hysteresis loop of CoCrPt-SiO<sub>2</sub> medium.

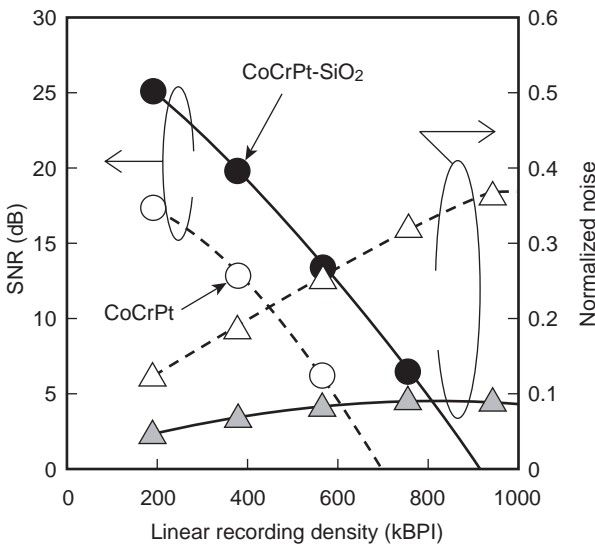

Figure 8  
Linear recording density dependence of SNR (circles) and normalized noise (triangles) of CoCrPt-SiO<sub>2</sub> media (black circles and triangles) and CoCrPt media (white circles and triangles).

magnetic field, the thermal stabilization and external magnetic field stabilization are deteriorated. These problems regarding the writing performance, thermal stabilization, and noise are solved by using the double recording layer.

The double recording layer consists of a low-noise magnetic recording layer and a continuous write assistance layer. We use CoCrPt-SiO<sub>2</sub> for the low-noise magnetic recording layer. In the con-

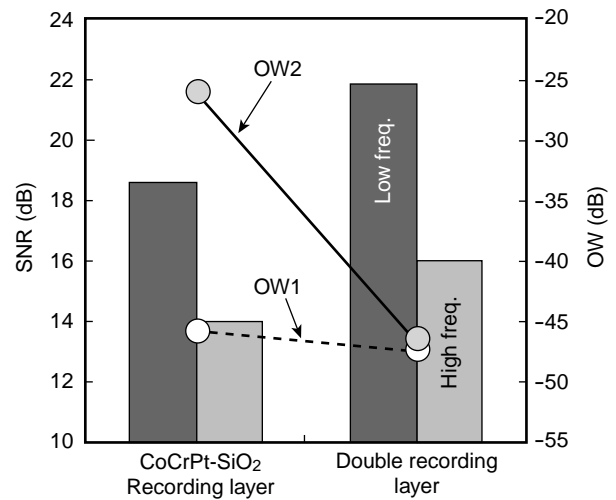

Figure 9  
SNR and OW of single CoCrPt-SiO<sub>2</sub> and double recording layer media. Black and gray columns are SNR at low and high frequency, respectively. White and gray circles show conventional Over Write (OW1) and reverse Over Write (OW2), respectively. Lower Ows indicate superior performance.

tinuous magnetic layer, the magnetic interaction between magnetic grains is stronger than in the low-noise magnetic recording layer. **Figure 9** shows the SNR and overwrite (OW), which is a measure of how well previous data is overwritten, of a CoCrPt-SiO<sub>2</sub> single recording layer medium and double recording layer medium. As can be seen, the OW and SNR are greatly improved in the double recording layer medium.

By combining the double recording layer medium with the above-mentioned thin APS-SUL and a trailing shielded head, we can reduce the spike noise and WATER to obtain a low enough BER for linear recording densities above 1100 kBPI. By using the technologies described above, we achieved an areal recording density of over 200 Gbit/in<sup>2</sup>.

### 3. PMR head

The PMR head has the same read element as the LMR head; therefore, in this section, we only focus on the write element of the PMR head.

There are three main issues regarding the PMR head. One is how to increase the recording

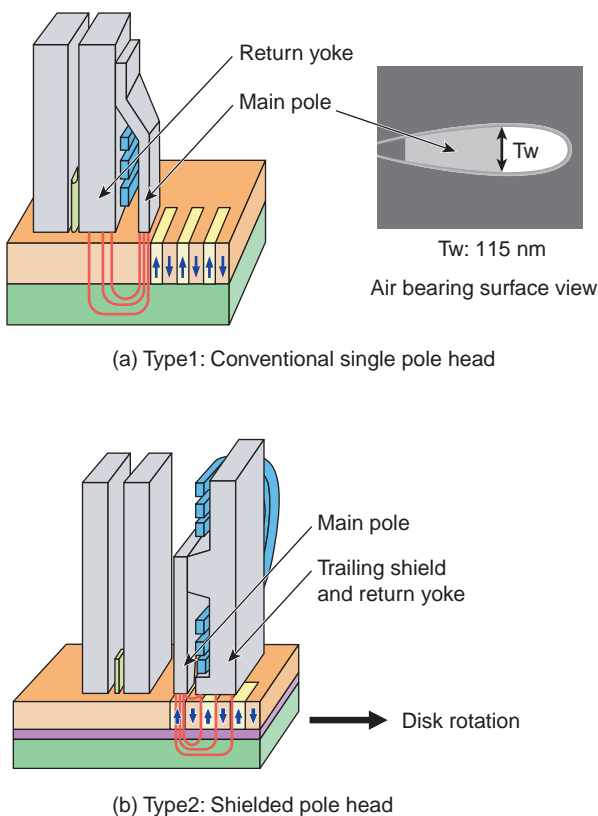

Figure 10 PMR head structures.

field gradient in order to obtain a higher bit density.<sup>11)</sup> **Figures 10 (a)** and **10 (b)** show two types of PMR head. The Type1 is a typical single-pole head consisting of a main pole, coil, and return yoke. The main pole and return yoke constitute a closed magnetic circuit together with the SUL of the medium. The recording field is generated at the main pole tip. In order to prevent erasure of adjacent tracks due to side protrusion of the main pole caused by operation of the head rotary actuator, the main pole tip has a reverse trapezoid shape.

Type2 is a newer shielded, single-pole head. The magnetic shield layer is positioned close to the trailing edge of the main pole. The magnetic recording field from the trailing edge of the main pole is absorbed by the trailing shield, and the recording field is tilted in the longitudinal direction. Consequently, a large recording field gradient, which is effective for reducing the mag-

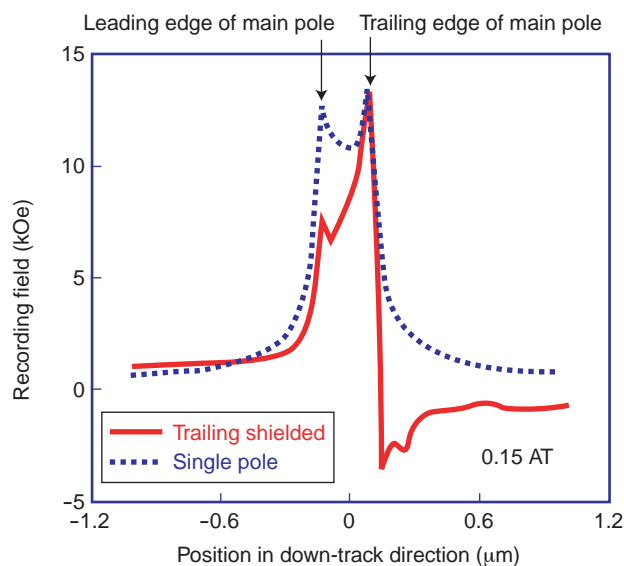

Figure 11 Recording field distribution of main pole in down-track direction.

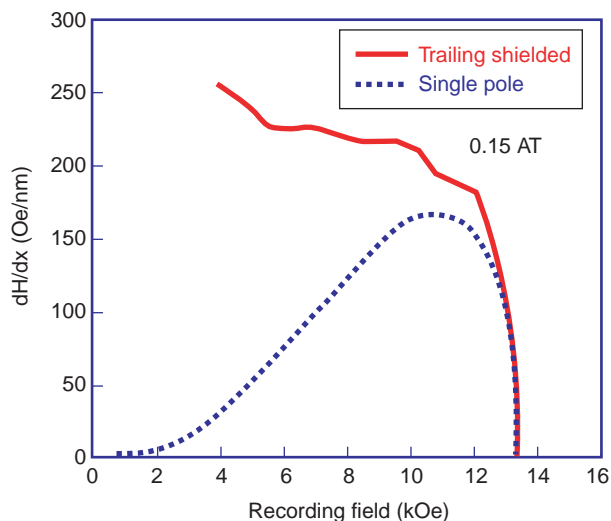

Figure 12 Recording field gradient.

netic transition jitter of the medium, is obtained at the trailing edge of the main pole. Also, the effective switching field for performing magnetization reversal in the recording layer is enhanced (**Figures 11** and **12**). We confirmed in write/read measurements that the shielded Type2 head can record at higher densities than the conventional Type1 head. More accurate size control in the tip region of the main pole and trailing shield is required in the Type2 head; however, this will be

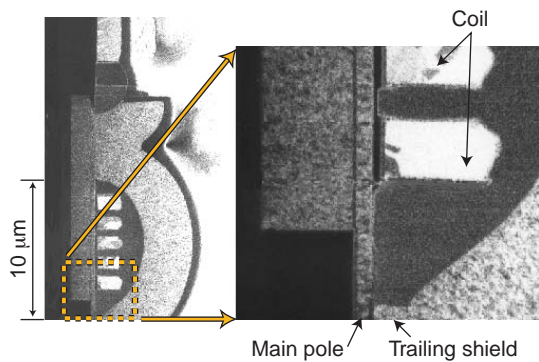

Figure 13  
Trial production head.

achieved as fabrication technology progresses.

The other issues are WATER and pole erasure (PE). The degree of WATER in an APS-SUL medium is lower than in a conventional SUL, and is dramatically reduced when APS-SUL is combined with a head whose magnetic flux does not pass over a wide area of the SUL.

PE is on-track erasure due to the remanence of the main pole tip after writing. PE will become more serious in the future as the track width becomes narrower. PE can be reduced by optimizing the depth/width ratio of the main pole tip and/or by controlling the magnetic anisotropy of the main pole by using materials that have a large reverse magnetostriction effect<sup>12)</sup> or a multilayered structure.<sup>13)</sup>

A trial production head is shown in **Figure 13**.

#### 4. Signal processing for PMR channels

The transition from LMR to PMR entails changes not only in the head and media technologies, but also in the signal processing technology. Current HDDs employ PR targets for shaping the read-back signal. Unlike LMR, PMR has a nonzero DC response. This suggests that the optimal PR targets of PMR and LMR are different. **Table 1** shows three types of fundamental PR targets — DC-full, DC-attenuated, and DC-free — for polynomial orders 1 to 4. In this section, we compare the performance of these targets as determined

Table 1  
Fundamental PR targets.

| Type \ n                                   | 1             | 2                 | 3                      | 4                                       |
|--|---------------|-------------------|------------------------|---|
| DC-full<br>(1+D) <sup>n</sup>              | PR1<br>[1, 1] | PR2<br>[1, 2, 1]  | PR2<br>[1, 3, 3, 1]    | E <sup>2</sup> PR2<br>[1, 4, 6, 4, 1]   |
| DC-attenuated<br>(2-D)(1+D) <sup>n-1</sup> |               | PR3<br>[2, 1, -1] | EPR3<br>[2, 3, 0, -1]  | E <sup>2</sup> PR3<br>[2, 5, 3, -1, -1] |
| DG-free<br>(1-D)(1+D) <sup>n-1</sup>       |               | PR4<br>[1, 0, -1] | EPR4<br>[1, 1, -1, -1] | E <sup>2</sup> PR4<br>[1, 2, 0, -2, -1] |

n: Polynomial order

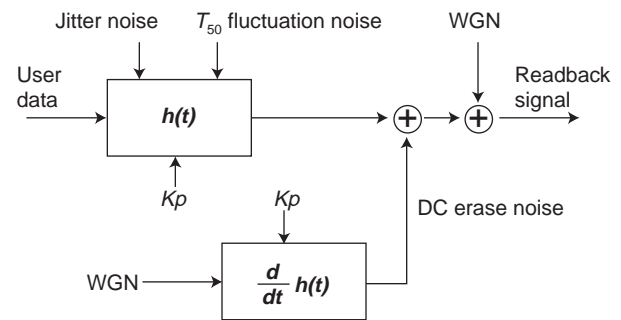

Figure 14  
Perpendicular channel model.

by BER simulation and investigate which of these targets are suited to PMR. Although several PMR targets have been investigated,<sup>14)-16)</sup> they are based on a relatively simple noise model. The simulation here is based on a full-noise model with a practical noise ratio that includes, especially,  $T_{50}$  fluctuation noise.

The channel is modeled with an isolated pulse of  $h(t) = A \cdot \tanh(\log(3) \cdot t / T_{50})$ , where  $A$  is half the amplitude and  $T_{50}$  is the time required for  $h(t)$  to rise from  $-A/2$  to  $A/2$ . Jitter noise,  $T_{50}$  fluctuation noise, DC erase noise, and white Gaussian noise (WGN) are applied as shown in **Figure 14**. The media noise power is 90% of the total noise power. The jitter,  $T_{50}$  fluctuation, and DC erase noise powers are 65%, 10%, and 25% of the media noise power, respectively. The channel is equalized with a 7<sup>th</sup>-order equi-ripple filter and a 10-tap finite impulse response filter. Single-parity codes with a code rate of 60/61 are used with a post-processor. The SNR is defined as:

$$SNR = 20 \log \left( A \sqrt{\int_0^T N(f) df} \right) \tag{1}$$

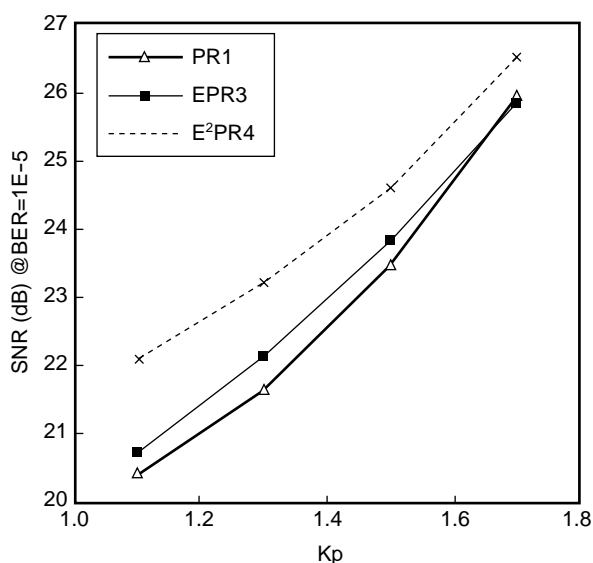

Figure 15  
Performance comparison of PR targets.

where  $N(f)$  is the spectral density of noise and  $f_n$  is the Nyquist frequency. We define the normalized linear density as  $K_p = T_{50}/T_b$ , where  $T_b$  is the recording bit interval.

Although not shown here, our simulation with  $K_p = 1.5$  indicates that PR1 performs best among the fundamental DC-full targets, and EPR3 performs best among the DC-attenuated targets. Among the DC-free targets, E<sup>2</sup>PR4 exhibits the best performance. It is important to note that the optimal polynomial order is lower for DC-full targets than for DC-attenuated targets. Because the DC-full targets have a higher DC component, the noise at low frequencies needs to be suppressed by decreasing the order of the target polynomial.

**Figure 15** compares the performance of the three best targets: PR1, EPR3, and E<sup>2</sup>PR4. Among them, PR1 performs best with  $K_p < 1.65$ . The DC-free target E<sup>2</sup>PR4 is inferior to PR1 by 1.1 dB at  $K_p = 1.5$ , which roughly corresponds to a 10% difference in linear recording density.

In commercial HDDs, the PR target is optimized more precisely, for example, to the generalized PR target.<sup>17)</sup> Noise prediction is also considered to improve the BER performance. However, the results shown here at least indicate

that a PR target containing a DC response can make a significant contribution toward the achievement of PMR densities beyond 200 Gbit/in<sup>2</sup>.

## 5. Conclusion

We have developed a new trailing-shielded pole head and an APS-SUL media for PMR using new technologies. These technologies solve the problems of noise from the SUL, wide area data erasure, and the high media production cost of thick SULs. Moreover, we developed a double recording layer medium that has improved SNR and OW properties. Furthermore, a PR target containing a DC response can make a significant contribution toward the achievement of higher PMR densities. We will apply these PMR technologies to produce HDDs having areal recording densities that exceed 130 Gbit/in<sup>2</sup>.

For recording density improvements beyond 200 Gbit/in<sup>2</sup>, we must solve the problem of pole erasure by the recording head, optimize the PR target, and improve the SNR. These goals will be achieved by controlling the magnetic anisotropy of the main pole, using a PR target that contains a DC response, and using new media structures such as the ECC media.<sup>18)</sup>

## References

- 1) S. Iwasaki et al.: An analysis for the Circular Mode of Magnetization in Short Wavelength Recording. *IEEE Trans. Magn.*, **11**, 5, p.1173-1175 (1975).
- 2) Y. Honda et al.: Effect of Soft Underlayer on Magnetization Microstructure of Perpendicular Thin Film Media. *IEEE Trans. Magn.*, **36**, 5, p.2399-2401 (2000).
- 3) B. Acharya et al.: Anti-Parallel Coupled Soft Under Layers for High-Density Perpendicular Recording. *IEEE Trans. Magn.*, **40**, 4, p.2383-2385 (2004).
- 4) S. Takenori et al.: Exchange-Coupled IrMn/CoZrNb Soft Underlayers for Perpendicular Recording Media. *IEEE Trans. Magn.*, **38**, 5, p.1991-1993 (2002).
- 5) W. Jiang et al.: Cross-track noise profile measurement for adjacent-track interference study and write-current optimization in perpendicular recording. *J. Appl. Phys.*, **93**, 10, p.6754-6756 (2003).

- 6) J. Feng: Long-Range Erasure of Nearby Recorded Tracks. *IEEE Trans. Magn.*, **40**, 4, p.2588-2590 (2004).
- 7) S. Okikawa et al.: High Performance CoPrCrO Single Layered Perpendicular Media with No Recording Demagnetization. *IEEE Trans. Magn.*, **36**, 5, p.2393-2395 (2000).
- 8) T. Okikawa et al.: Microstructure and Magnetic Properties of CoPtCr-SiO<sub>2</sub> Perpendicular Recording Media. *IEEE Trans. Magn.*, **38**, 5, p.1976-1978 (2002).
- 9) N. Honda et al.: Overview of Recent Work on Perpendicular Magnetic Recording Media (in Japanese), *J. Magn. Soc. Jpn.*, **24**, p.1027 (2000).
- 10) H. Ohmori et al.: Magnetic properties and noise characteristics of Co/Pd multilayer perpendicular magnetic recording media. *J. Magn. Magn. Mat.*, **235**, p.45 (2001).
- 11) K. Miura et al.: Effect of Head Field Gradient on Transition Jitter in Perpendicular Magnetic Recording. *IEEE Trans. Magn.*, **37**, 4, p.1926-1928 (2001).
- 12) K. Hirata et al.: A study of pole material properties for pole erasure suppression in perpendicular recording heads. *J. Magn. Magn. Mat.*, **287**, p.352 (2005).
- 13) K. Nakamoto et al.: Single-Pole/TMR Heads for 140-Gbit/in<sup>2</sup> Perpendicular Recording. *IEEE Trans. Magn.*, **40**, 1, p.290-294 (2004).
- 14) Y. Okamoto and et al.: Performance of PRML systems in perpendicular magnetic recording channel with jitter-like noise. *J. Magnetism and Magnetic Materials*, **235**, p.259-264 (2001).
- 15) R. Cideciyan, E. Eleftheriou, and T. Mittelholzer: Perpendicular and longitudinal recording: a signal-processing and coding perspective. *IEEE Trans. Magn.*, **38**, 4, p.1698-1704 (2002).
- 16) M. Madden, M. Oberg, Z. Wu, and R. He: Read channel for perpendicular magnetic recording. *IEEE Trans. Magn.*, **40**, 1, p.241-246 (2004).
- 17) H. Sawaguchi, Y. Nishida, H. Takano, and H. Aoi: Performance analysis of modified PRML channels for perpendicular recording systems. *J. Magnetism and Magnetic Materials*, **235**, p.265-272 (2001).
- 18) Victora, R. H.; Xiao Shen: Composite media for perpendicular magnetic recording. *Magnetics, IEEE Trans. Magn.*, **41**, 2, p.537-542 (2005).



**Isatake Kaitsu** received the B.S. and M.S. degrees in Solid State Physics from Osaka City University, Osaka, Japan in 1988 and 1990, respectively. He joined Fujitsu Laboratories Ltd., Atsugi, Japan in 1990, where he has been researching and developing magnetic recording media for HDDs.

E-mail: kaitsu.isatake@jp.fujitsu.com



**Junzo Toda** received the B.S. and M.S. degrees in Electronics Engineering from Osaka University, Osaka, Japan in 1974 and 1976, respectively. He joined Fujitsu Laboratories Ltd., Atsugi, Japan in 1976, where he has been researching and developing materials and fabrication processes for thin film magnetic recording heads. He is a member of the Magnetic Society of Japan (MSJ) and the Storage Research Consortium (SRC).

E-mail: toda.junzo@jp.fujitsu.com



**Ryosaku Inamura** received the B.S. and M.S. degrees in Magnetism Physics from Gakushuin University, Tokyo, Japan in 1997 and 1999, respectively. He joined Fujitsu Laboratories Ltd., Atsugi, Japan in 1999, where he has been researching and developing magnetic recording media for HDDs.

E-mail: inamura.ryosaku@jp.fujitsu.com



**Toshihiko Morita** received the B.E. degree in Mechanical Engineering and the Ph.D. degree in Engineering from the University of Tokyo, Tokyo, Japan in 1984 and 2003, respectively. He joined Fujitsu Laboratories Ltd., Japan in 1984, where he has been researching and developing systems for coding, signal processing, and robot vision. He is a member of the IEICE of Japan, the Robotics Society of Japan, and the IEEE.

E-mail: tmorita@jp.fujitsu.com